

**Note: Footnotes begin on page 5.**

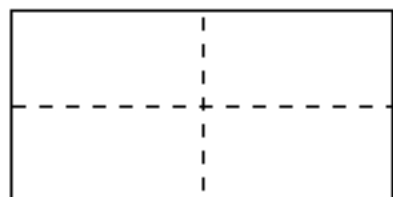

1. Begin with a 1x2 rectangle, either side up. Book fold and unfold twice.



2. PATWT<sup>1</sup>, fold point A to B.

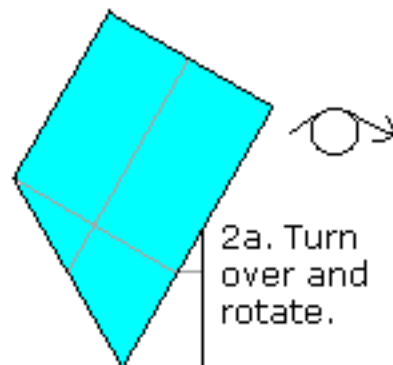

2a. Turn over and rotate.

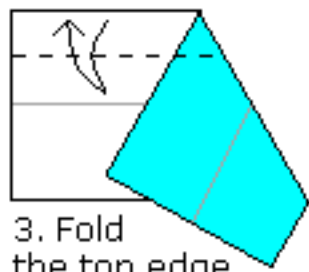

3. Fold the top edge to the center and unfold.

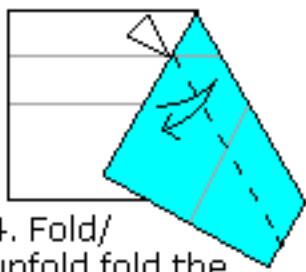

4. Fold/unfold fold the left colored edge to the crease near the white triangle.



5. PATWT, fold perpendicularly to the left colored edge.



6. Fold and unfold along the crease on the lower layer.

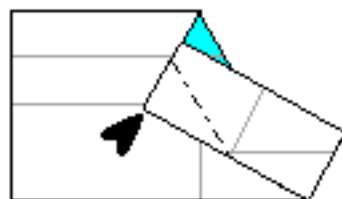

7. Reverse fold.



8. Unfold completely.

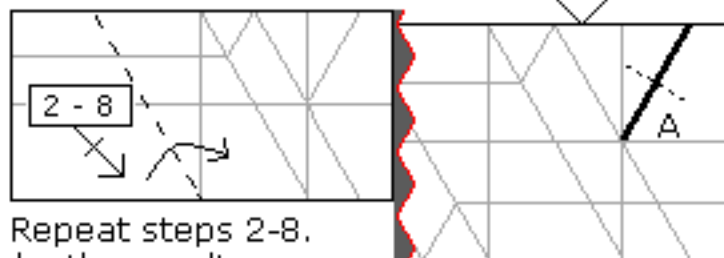

9. Repeat steps 2-8. Make the result mirrored vertically by making step 2 so.

10. Creasing only at segment A, fold one endpoint to the other and unfold.

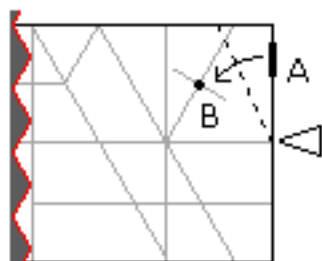

11. PATWT, fold line A to point B.

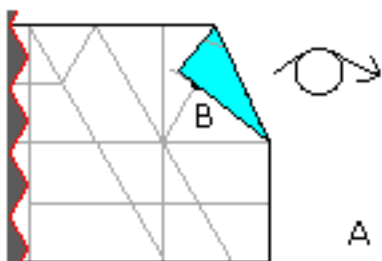

11a. Turn over.

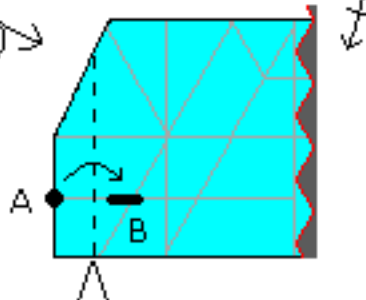

12. PATWT, fold point A to line B. If all folds were accurate, A will **not** hit the intersection at B. Repeat vert. mirrored on the right.

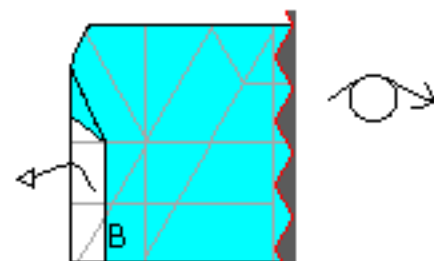

13. Unfold completely. Turn over.

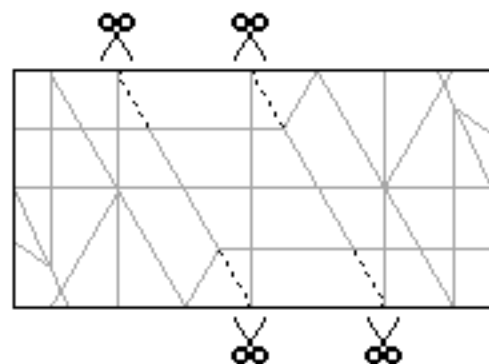

14. Make four small snips along the dotted lines.

**Criss-Cross Hexagon Unit**

*It the it  
6/29/17  
Revision 1*

15. Fold each indicated edge that was made by the cuts.

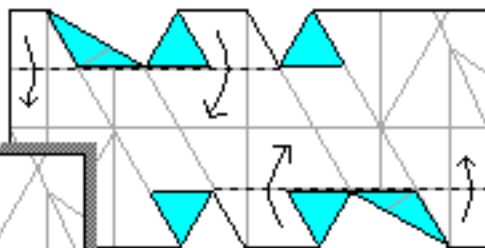
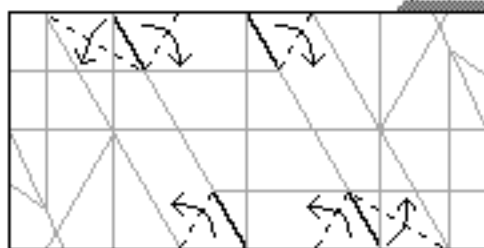

16.

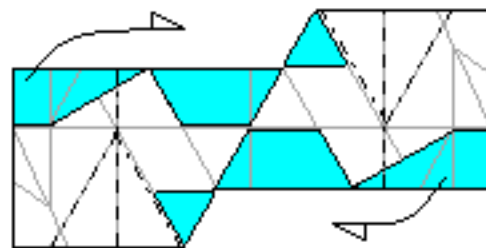

17. Re-form the reverse folds from step 7, which will face behind the model.

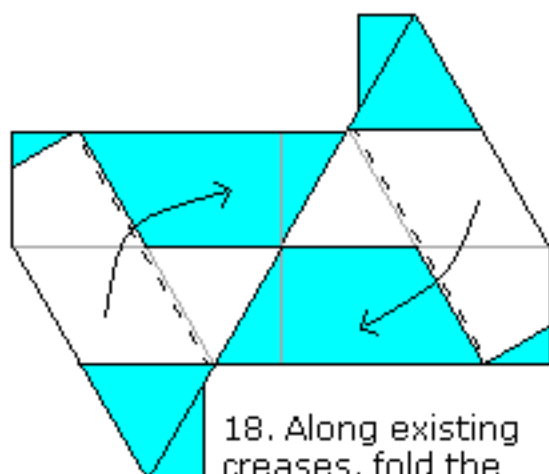

18. Along existing creases, fold the edges to the center while swinging out the rear flaps.

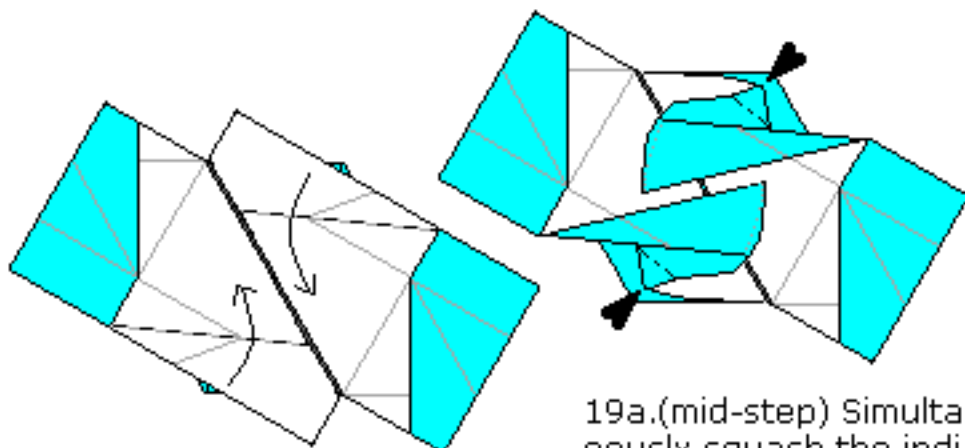

19. Fold along existing creases. The layers underneath will not lie flat.

19a.(mid-step) Simultaneously squash the indicated corners and press the central flaps down.

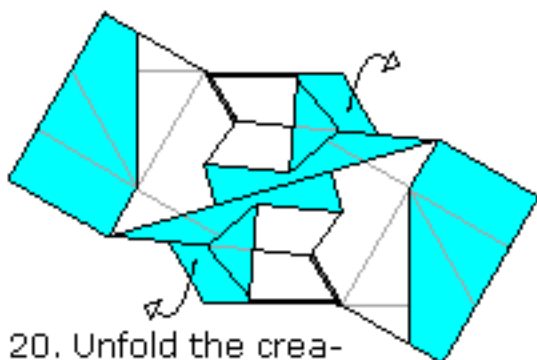

20. Unfold the creases from step 18.

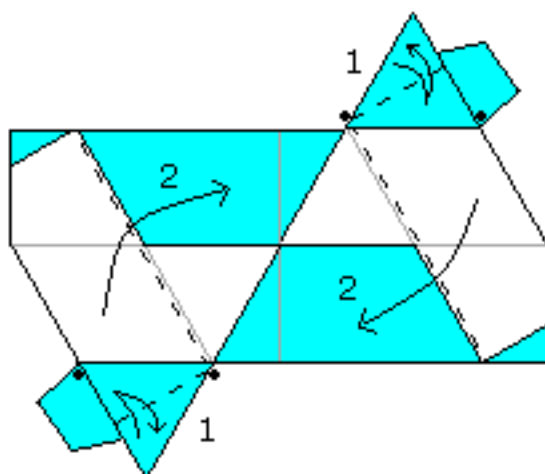

21. 1: Fold the edges of the triangles to lie at the dots, which are a bit above the indicated yellow edges. Unfold. 2: Repeat step 18.

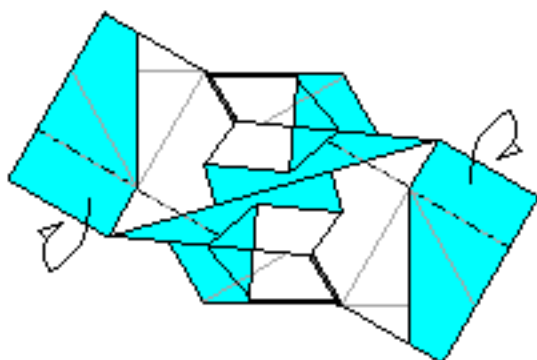

22. Re-fold the creases from step 12.

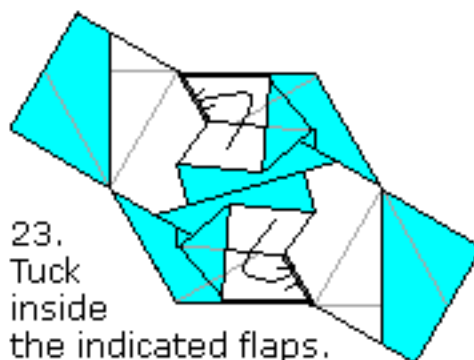

23. Tuck inside the indicated flaps.

*Griss-Cross  
Hexagon Unit*

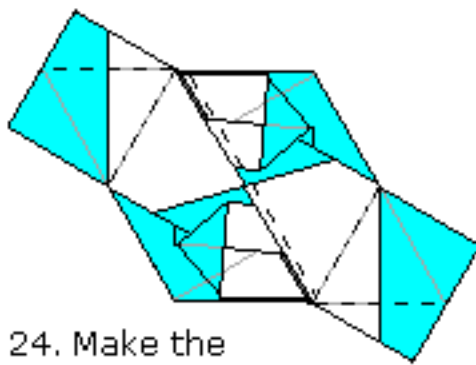

24. Make the indicated creases.

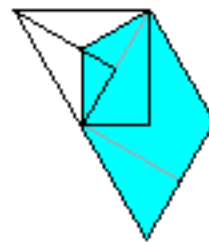

25. Unfold last step, then bring the flaps indicated in step 21 to the top.

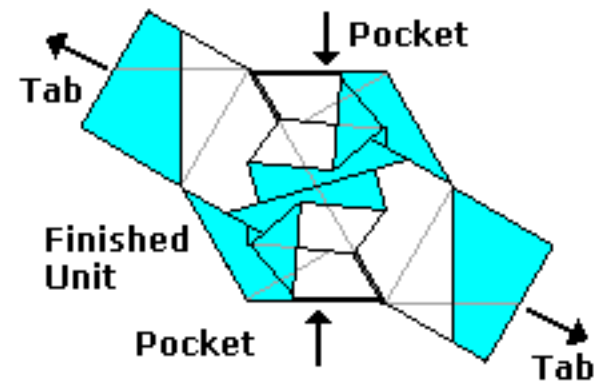

(For the number of units to make, see page 4.)

**Assembly:**

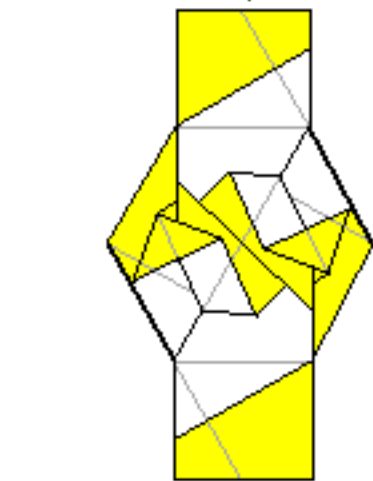
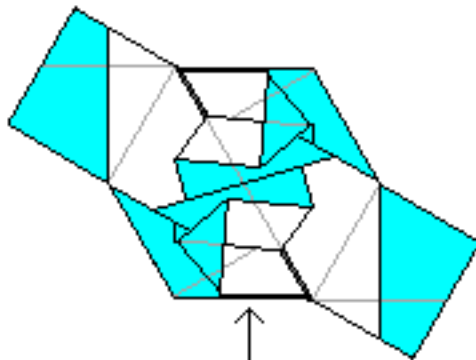

(1) Insert the tab under the reverse fold from step 7.



(2) (Joint shown only.) To lock, mountain fold (along the short crease from step 21) the indicated flap into the second unit's hidden pocket. Tuck the flap marked with an asterisk inside.



(2a) Result. Rotate 90 deg. clockwise.

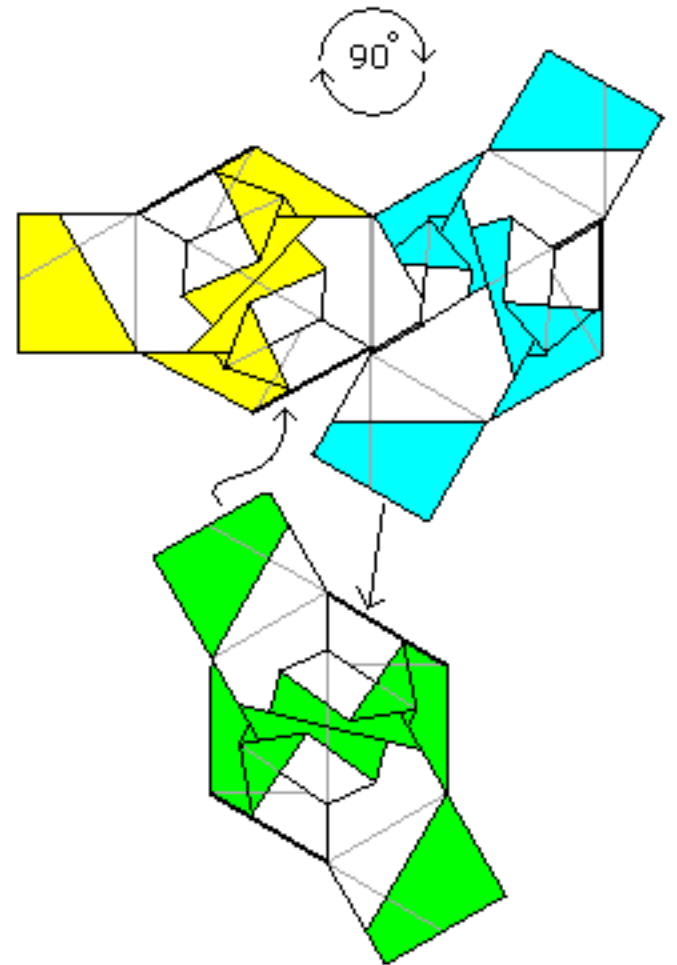

(3.) Insert a third unit. Mountain fold the locking flaps and tuck the adjacent flaps as in step (2).

*Griss-Cross  
Hexagon Unit*

*It the it  
6/29/17  
Revision 1*



(4.) Before inserting the next units, apply the indicated existing creases. The point surrounded by the three central mountain creases will convex.

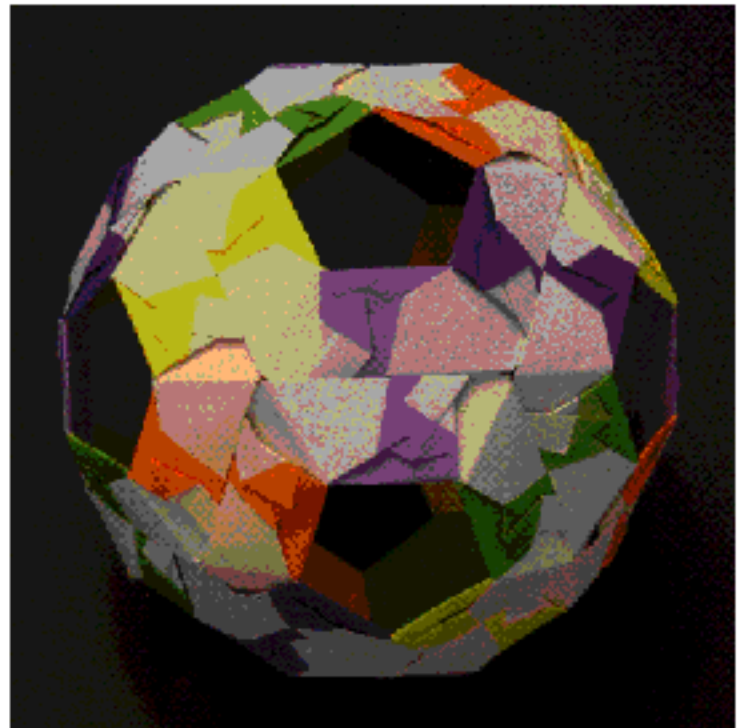
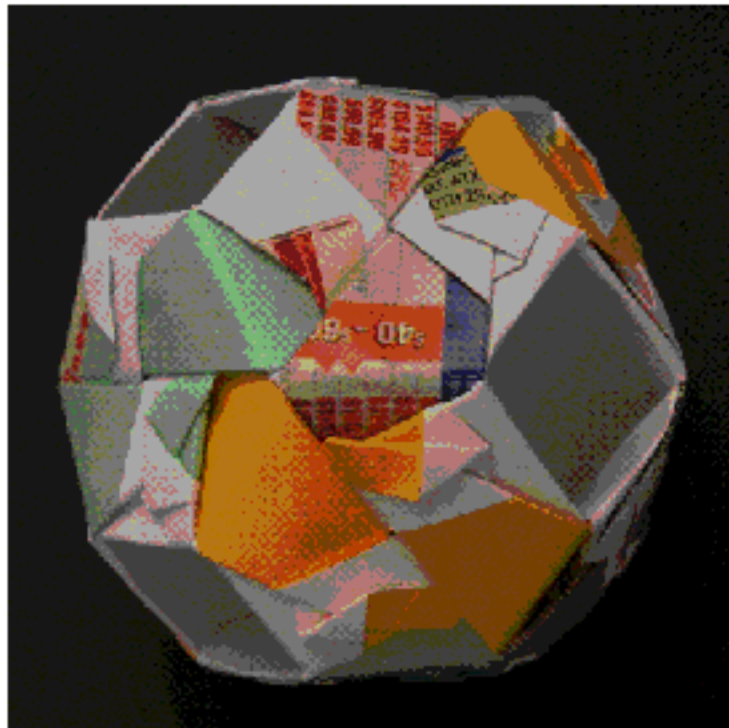

**Left: 12-unit cubic assembly  
Right: 30-unit dodecahedral assembly**

*Griss-Cross Hexagon Unit*

*It the it  
6/29/17  
Revision 1*

Note: This unit arranges in assemblies in the same way as Francis Ow's 120° unit or 135° unit; therefore, you could also make with 12 units an octahedral assembly. However, if you reverse each of the creases indicated in step (4), (which would mean making the central creases mountain creases,) the flaps that tuck inside might not remain inside very well. In this case, you could try avoiding creasing them at the edge under which they tuck. For a complete list of the polyhedra creatable from this type of unit, visit [http://www.nickrobinson.info/clients/owrigami/show\\_diagram.php?diagram=120](http://www.nickrobinson.info/clients/owrigami/show_diagram.php?diagram=120) or [http://www.nickrobinson.info/clients/owrigami/show\\_diagram.php?diagram=135](http://www.nickrobinson.info/clients/owrigami/show_diagram.php?diagram=135). (The text after the "?" is necessary.)

**Footnotes:**

1: "PATWT" means "pivoting at the white triangle."

2: Note that, if you cut out the paper accurately and folded accurately, the white edge will lie a bit below the encircled point. This point is where the adjacent crease hits the yellow folded edge underneath.